

CW 170 V1

Compact Height

| | | | |
|-----|---------------------|--|--|
| BMW | B2 4005 | | |
| MB | B8 3180 220 000 004 | | |
| VW | 39D 997 | | |

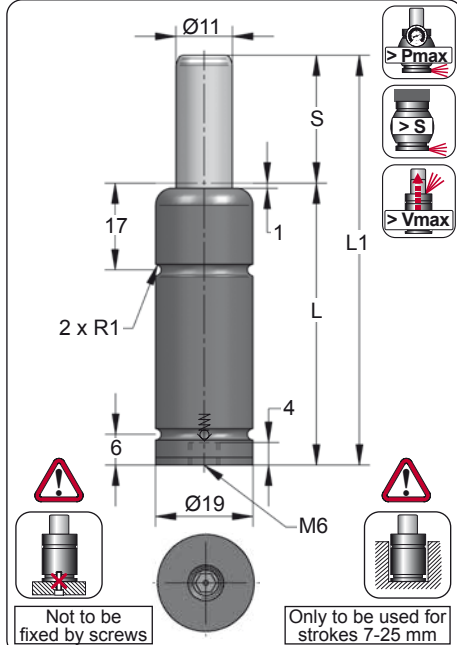

| ORDER | S (mm) | L1 ±0.25 (mm) | L (mm) | Kg. |
|---------------|--------|---------------|--------|------|
| CW 170 007 V1 | 7 | 44 | 37 | 0.08 |
| CW 170 010 V1 | 10 | 50 | 40 | 0.08 |
| CW 170 013 V1 | 13 | 56 | 43 | 0.08 |
| CW 170 015 V1 | 15 | 60 | 45 | 0.09 |
| CW 170 019 V1 | 19 | 68 | 49 | 0.09 |
| CW 170 025 V1 | 25 | 80 | 55 | 0.10 |
| CW 170 032 V1 | 32 | 94 | 62 | 0.11 |
| CW 170 038 V1 | 38 | 106 | 68 | 0.12 |
| CW 170 050 V1 | 50 | 130 | 80 | 0.13 |
| CW 170 063 V1 | 63 | 156 | 93 | 0.15 |
| CW 170 075 V1 | 75 | 185 | 110 | 0.16 |
| CW 170 080 V1 | 80 | 195 | 115 | 0.17 |
| CW 170 100 V1 | 100 | 235 | 135 | 0.20 |
| CW 170 125 V1 | 125 | 285 | 160 | 0.23 |



| CODE | Pressure Gauge | bar | psi | F ₀ daN | F ₁ daN |
|---------------|----------------|-----|------|--------------------|--------------------|
| CW 170 050 V1 | | 180 | 2610 | 170 | 295 |
| ----- | | --- | --- | --- | --- |

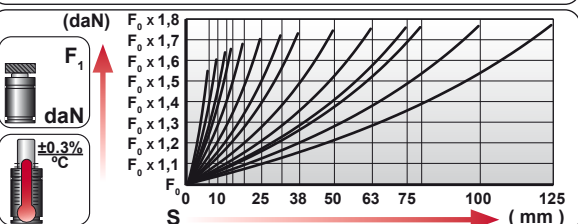
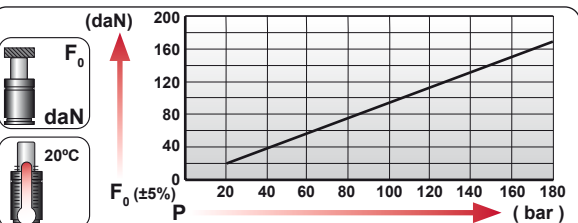

VDI 3003

↑ ↓ ↻

EQUIPPED WITH VDI - SAFETY

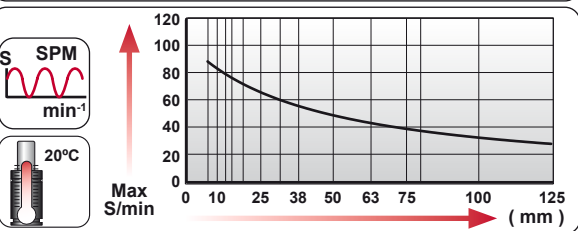

| | | |
|---------------|---|----------------------------|
| | ENG ORDER DEU BESTELLUNG FRA COMMANDE ITA ORDINE ESP PEDIDO POR PEDIDO | F ₀ daN S mm |
| CW 170 050 V1 | | 170 50 |

| | | | | | | | |
|--|------------------------|--------------------------|-------------------------|-------------------------|------------------|------------------|--|
| | S _{max} < 90% | V _{max} 1,6 m/s | P _{min} (20°C) | P _{max} (20°C) | T _{min} | T _{max} | |
|--|------------------------|--------------------------|-------------------------|-------------------------|------------------|------------------|--|

| | | | | | | | |
|----------------|------------------------|--------------------------|---------|----------|-------|--------|---|
| N ₂ | S _{max} < 90% | V _{max} 1,6 m/s | bar psi | bar psi | °C °F | °C °F | ✗ |
| | | | 20 290 | 180 2610 | 0 32 | 80 176 | |



CW 170 V1 MOUNTS

Compact Height

A14-019

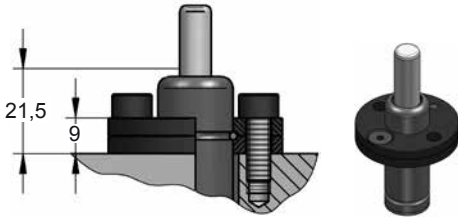
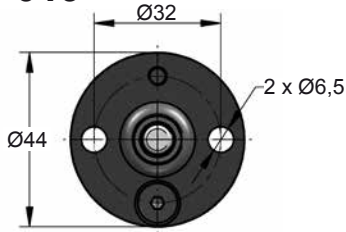

A19-019

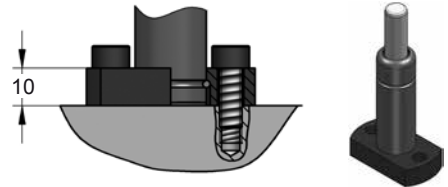
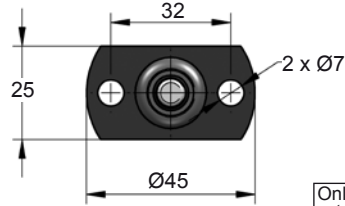

A44-019

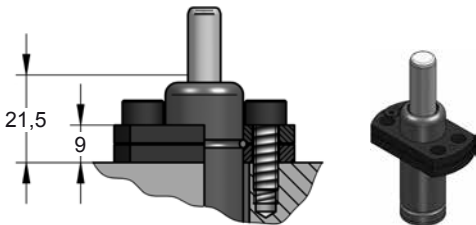
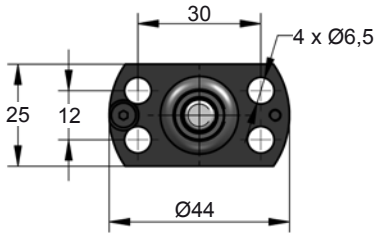

A59-019

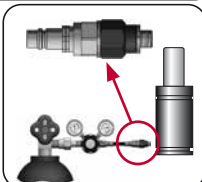
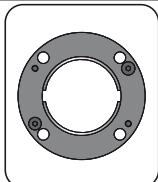
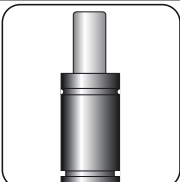
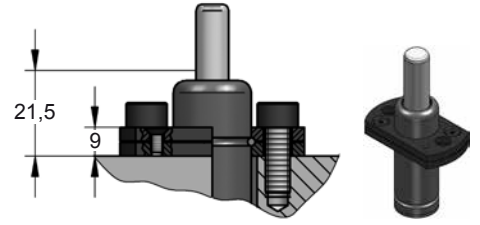
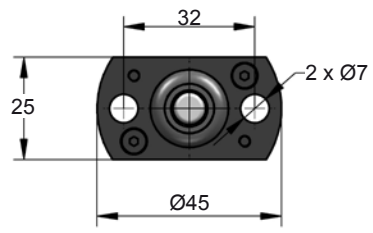

| CODE | CW 170 050 V1 | X | A14-019 | 06 CG 2-Q |
|----------------|-------------------|---------------------|-----------|----------------------|
| ENG ORDER | GAS SPRING | REPAIR KIT | FLANGE | CHARGING ADAPTER |
| DEU BESTELLUNG | GASDRUCKFEDER | ERSATZTEILSATZ | FLANSCHEN | LADEADAPTER |
| FRA COMMANDE | RESSORT À GAZ | KIT DE RÉPARATION | BRIDE | RACCORD DE CHARGE |
| ITA ORDINE | CILINDRO AD AZOTO | KIT DI MANUTENZIONE | FLANGE | ADATTATORE DI CARICO |
| ESP PEDIDO | RESORTE DE GAS | KIT DE REPARACION | BRIDA | ADAPTADOR DE CARGA |
| POR PEDIDO | CILINDRO DE GÁS | KIT DE MANUTENÇÃO | FLANGE | ADAPTADOR DE CARGA |