

# CD 300 V1

Heavy Duty

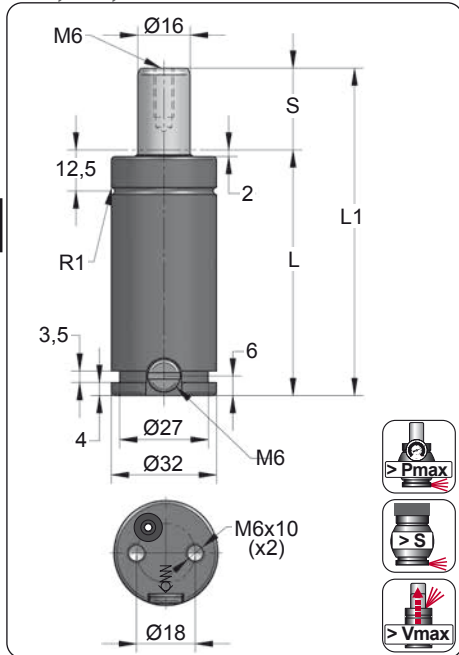

ORDER	S (mm)	L1 ±0.25 (mm)	L (mm)	Kg.
CD 300 010 V1	10	70	60	0.28
CD 300 012 V1	12.7	75.4	62.7	0.29
CD 300 016 V1	16	82	66	0.30
CD 300 025 V1	25	100	75	0.33
CD 300 038 V1	38	126	88	0.38
CD 300 050 V1	50	150	100	0.42
CD 300 063 V1	63.5	177	113.5	0.46
CD 300 080 V1	80	210	130	0.52
CD 300 100 V1	100	250	150	0.59
CD 300 125 V1	125	300	175	0.67

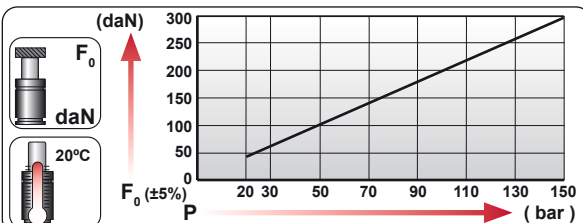

CODE	Pressure Gauge	bar	psi	F <sub>0</sub> daN	F <sub>1</sub> daN
CD 300 050 V1		150	2175	300	445
CD-H 300 050 V1		0	0	---	---

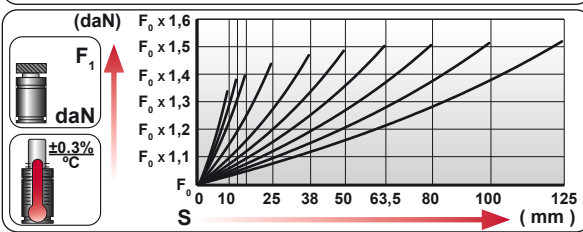

**EQUIPPED WITH VDI - SAFETY**

Language	ORDER	F <sub>0</sub> daN	S mm
ENG	BESTELLUNG	300	50
DEU	BESTELLUNG	300	50
FRA	COMMANDE	300	50
ITA	ORDINE	300	50
ESP	PEDIDO	300	50
POR	PEDIDO	300	50

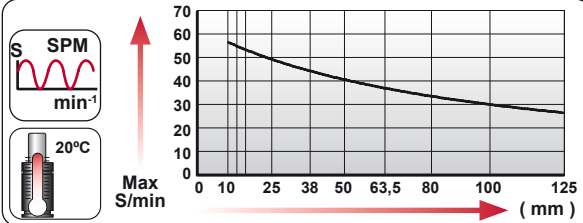

--	--	--	--	--	--	--	--

N <sub>2</sub>	Smax < 90%	Vmax 1,6 m/s	bar psi	bar psi	°C °F	°C °F	600 CP-
			20 290	150 2175	0 32	80 176	

## A14-032

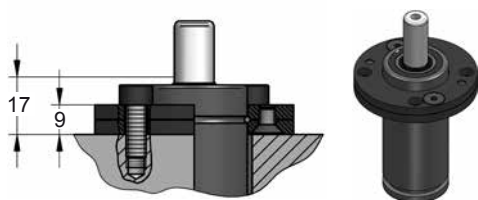
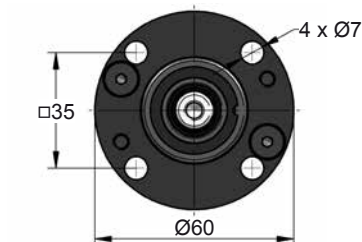

## A34-032

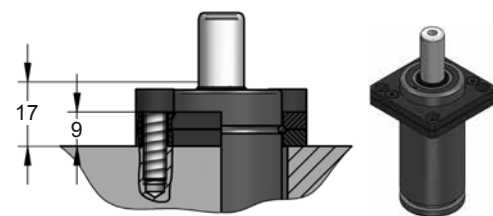
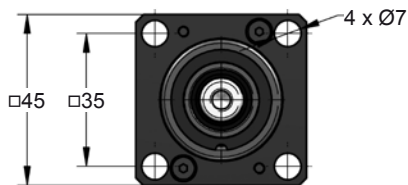

## C20-032

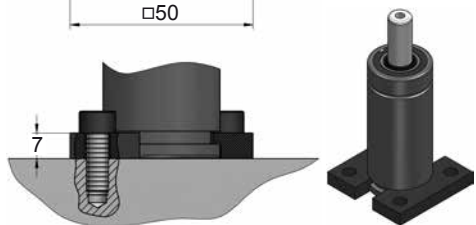
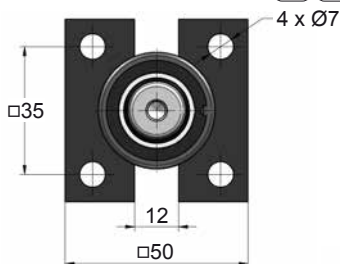

## D02-032

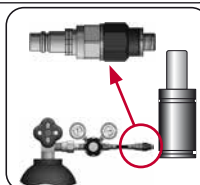
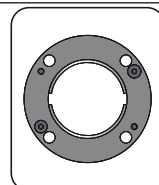
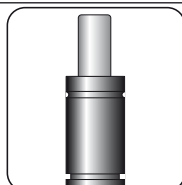
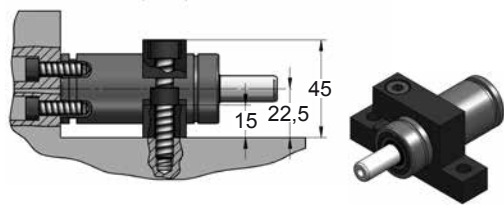
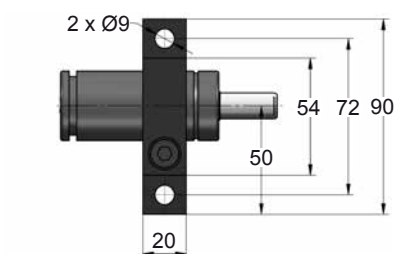

CODE	CD 300 050 V1	KIT S-XXXXXXX KIT C-XXXXXXX	A14-032	06 CG 2-Q
ENG ORDER	GAS SPRING	REPAIR KIT	FLANGE	CHARGING ADAPTER
DEU BESTELLUNG	GASDRUCKFEDER	ERSATZTEILSATZ	FLANSCHEN	LADEADAPTER
FRA COMMANDE	RESSORT À GAZ	KIT DE RÉPARATION	BRIDE	RACCORD DE CHARGE
ITA ORDINE	CILINDRO AD AZOTO	KIT DI MANUTENZIONE	FLANGE	ADATTATORE DI CARICO
ESP PEDIDO	RESORTE DE GAS	KIT DE REPARACION	BRIDA	ADAPTADOR DE CARGA
POR PEDIDO	CILINDRO DE GÁS	KIT DE MANUTENÇÃO	FLANGE	ADAPTADOR DE CARGA