

AFH V1

Mini

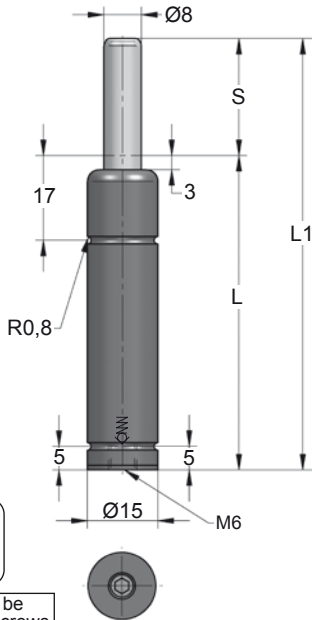



CODE	S (mm)	L1 ±0,25 (mm)	L (mm)	Kg.
AFH ... 007 V1	7	56	49	0.05
AFH ... 010 V1	10	62	52	0.06
AFH ... 012 V1	12.7	67.4	54.7	0.06
AFH ... 015 V1	15	72	57	0.06
AFH ... 019 V1	19	80	61	0.06
AFH ... 025 V1	25	92	67	0.07
AFH ... 038 V1	38	118	80	0.08
AFH ... 050 V1	50	142	92	0.10
AFH ... 063 V1	63.5	172	108.5	0.11
AFH ... 075 V1	75	195	120	0.12
AFH ... 080 V1	80	205	125	0.13

CODE	COLOR	Pressure (bar)		Force (daN)	
		bar	psi	F ₀ daN	F ₁ daN
AFH 18 050 V1	Green	35	510	18	35
AFH 35 050 V1	Blue	70	1015	35	70
AFH 50 050 V1	Red	100	1450	50	100
AFH 70 050 V1	Yellow	140	2030	70	140
AFH XX 050 V1	Black	20-180	290-2610	10 - 90	20 - 180

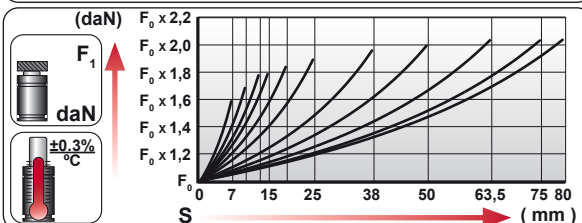
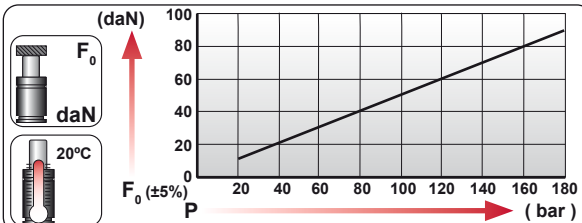

Language	Ordering Term	F ₀ (daN)	S (mm)
ENG	ORDER	90	50
DEU	BESTELLUNG		
FRA	COMMANDE		
ITA	ORDINE		
ESP	PEDIDO		
POR	PEDIDO		

AFH 90 050 V1

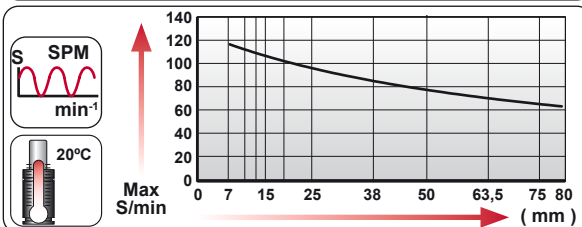

N ₂	S _{max} < 90%	V _{max} 1,6 m/s	bar psi	bar psi	°C	°F	°C	°F	X
			20 290	180 2610	0	32	80	176	

Mini

A14-015

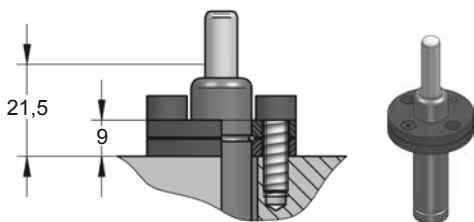
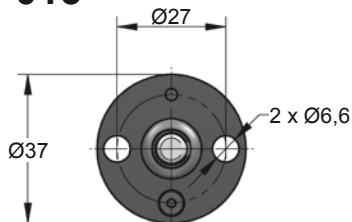

A49-015

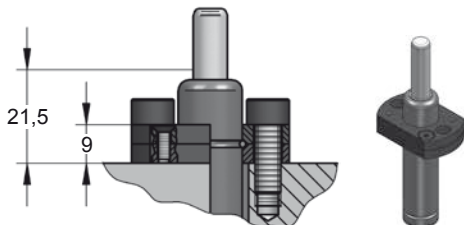
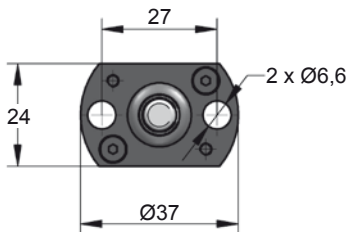

Single base thread

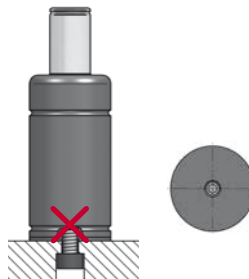

Gas springs with only a single base thread should not be mounted by screws.

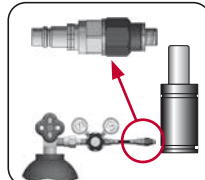
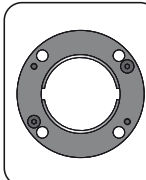
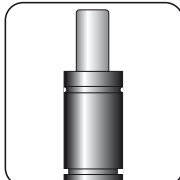

CODE	AFH 90 050 V1	X	A14-015	06 CG 2-Q
ENG ORDER	GAS SPRING	REPAIR KIT	FLANGE	CHARGING ADAPTER
DEU BESTELLUNG	GASDRUCKFEDER	ERSATZTEILSATZ	FLANSCHEN	LADEADAPTER
FRA COMMANDE	RESSORT À GAZ	KIT DE RÉPARATION	BRIDE	RACCORD DE CHARGE
ITA ORDINE	CILINDRO AD AZOTO	KIT DI MANUTENZIONE	FLANGE	ADATTATORE DI CARICO
ESP PEDIDO	RESORTE DE GAS	KIT DE REPARACION	BRIDA	ADAPTADOR DE CARGA
POR PEDIDO	CILINDRO DE GÁS	KIT DE MANUTENÇÃO	FLANGE	ADAPTADOR DE CARGA