

AG 150

150

BMW B2 4006		PSA E24.54.815.G
MB B8 3180 220 000 001	GM 90.25.00	RENAULT EM24.54.700
VW 39D 878		

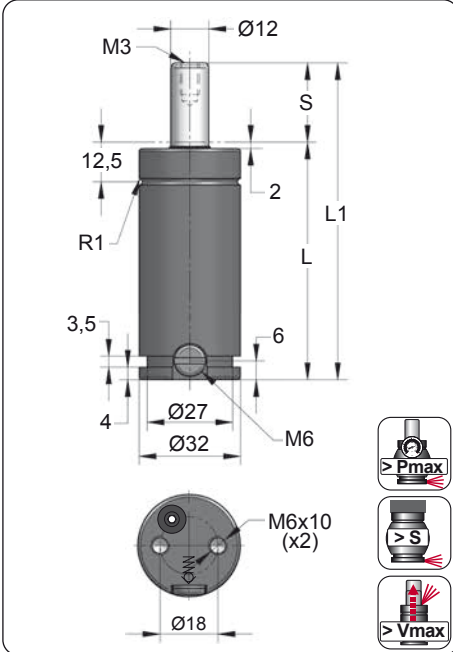

ORDER	S (mm)	L1 ±0.25 (mm)	L (mm)	Kg.
AG --- 010	10	70	60	0.27
AG --- 012	12.7	75.4	62.7	0.28
AG --- 016	16	82	66	0.29
AG --- 025	25	100	75	0.32
AG --- 038	38	126	88	0.36
AG --- 050	50	150	100	0.39
AG --- 063	63.5	177	113.5	0.44
AG --- 080	80	210	130	0.49
AG --- 100	100	250	150	0.55
AG --- 125	125	300	175	0.62

ORDER	COLOR	bar	psi	F ₀ daN	F ₁ daN
AG 50 050	Green	45	650	50	65
AG 100 050	Blue	90	1305	100	125
AG 150 050	Red	135	1960	150	190
AG 200 050	Yellow	180	2610	200	250
AG XXX 050	Black	20-180	290-2610	23 - 200	30 - 250



CODE	Pressure Gauge	bar	psi	F ₀ daN	F ₁ daN
AG 150 050		135	1960	150	188
AG-H 150 050		0	0	---	---

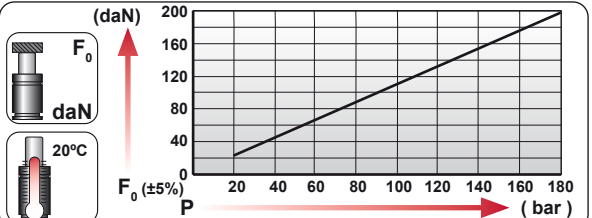

EQUIPPED WITH VDI - SAFETY

	ENG ORDER		
	DEU BESTELLUNG	daN	mm
	FRA COMMANDE		
	ITA ORDINE		
	ESP PEDIDO		
POR PEDIDO			
AG 150 050	150	50	

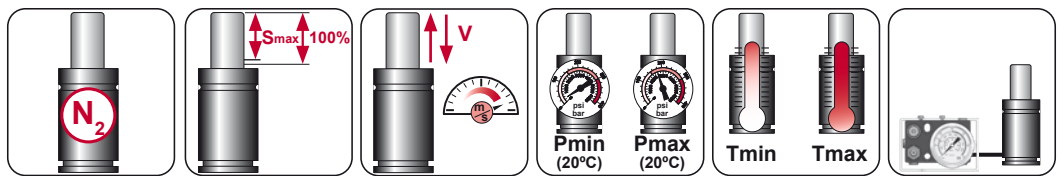
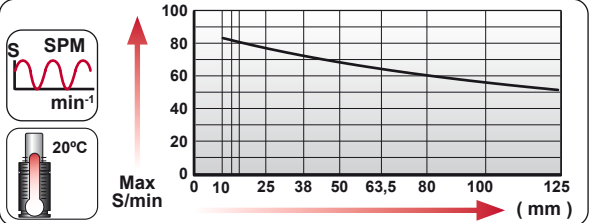
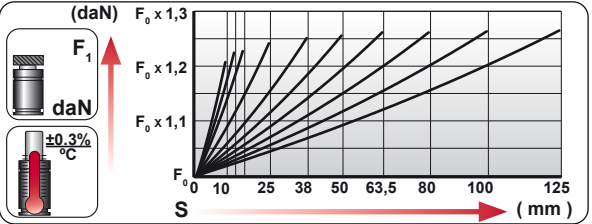

N ₂	Smax < 90%	Vmax 1,6 m/s	bar psi	bar psi	°C °F	°C °F	600 CP-
			20 290	180 2610	0 32	80 176	

A14-032

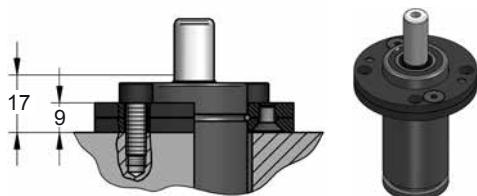
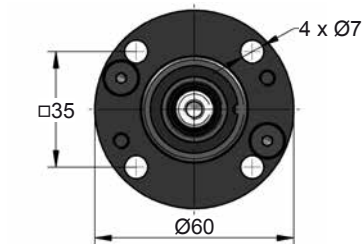

A34-032

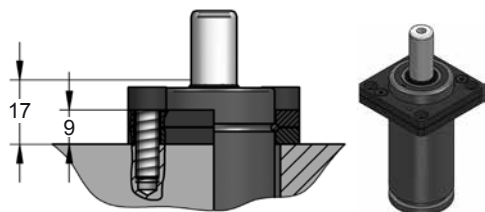
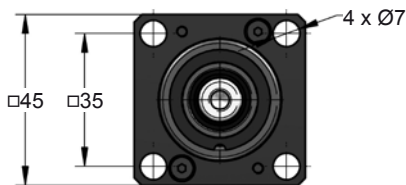

C20-032

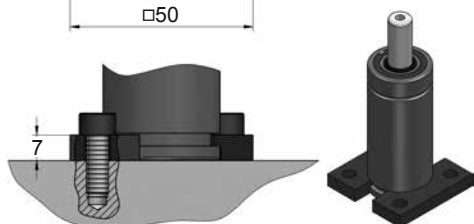
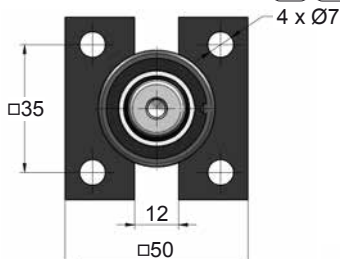

D02-032

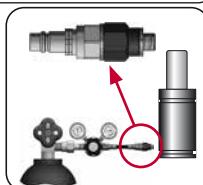
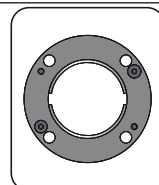
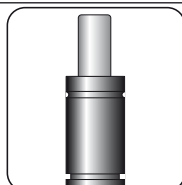
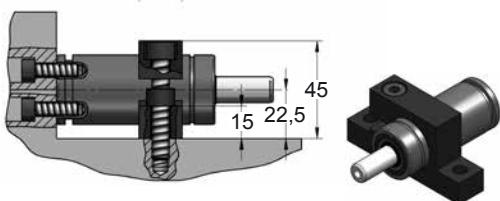
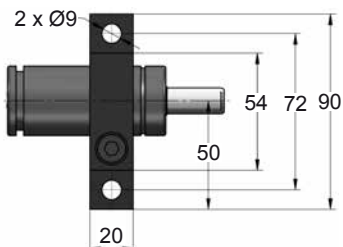

CODE	AG 150 050	KIT S-XXXXXXX KIT C-XXXXXXX	A14-032	06 CG 2-Q
ENG ORDER	GAS SPRING	REPAIR KIT	FLANGE	CHARGING ADAPTER
DEU BESTELLUNG	GASDRUCKFEDER	ERSATZTEILSATZ	FLANSCH	LADEADAPTER
FRA COMMANDE	RESSORT À GAZ	KIT DE RÉPARATION	BRIDE	RACCORD DE CHARGE
ITA ORDINE	CILINDRO AD AZOTO	KIT DI MANUTENZIONE	FLANGE	ADATTATORE DI CARICO
ESP PEDIDO	RESORTE DE GAS	KIT DE REPARACION	BRIDA	ADAPTADOR DE CARGA
POR PEDIDO	CILINDRO DE GAS	KIT DE MANUTENÇÃO	FLANGE	ADAPTADOR DE CARGA