

# ASP 300

Threaded

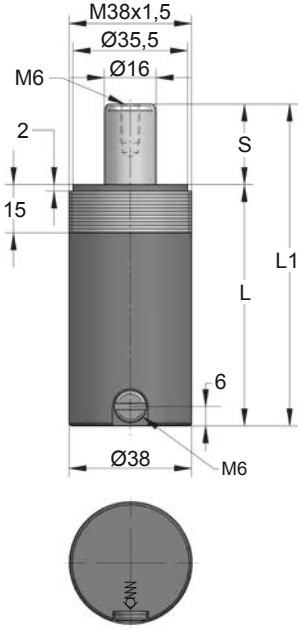

ORDER	S (mm)	L1 ±0,25 (mm)	L (mm)	Kg.
ASP 300 013	13	76	63	0.45
ASP 300 025	25	100	75	0.51
ASP 300 038	38	126	88	0.58
ASP 300 050	50	150	100	0.64
ASP 300 063	63.5	177	113.5	0.70
ASP 300 080	80	210	130	0.79
ASP 300 100	100	250	150	0.89

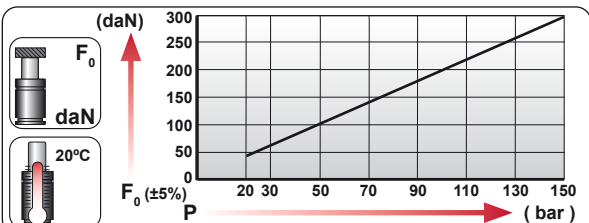

CODE	Pressure (bar)	Pressure (psi)	F <sub>0</sub> (daN)	F <sub>1</sub> (daN)
ASP 300 050	150	2175	300	410
-----	-----	-----	-----	-----

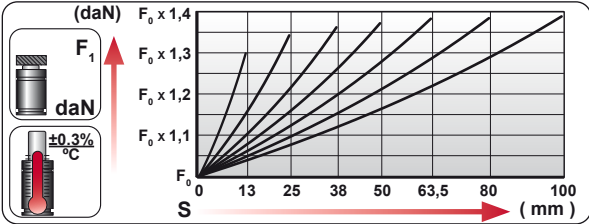

ENG ORDER  
 DEU BESTELLUNG  
 FRA COMMANDE  
 ITA ORDINE  
 ESP PEDIDO  
 POR PEDIDO

F<sub>0</sub> daN  
 S mm

**ASP 300 50**  
**ASP 300 050**

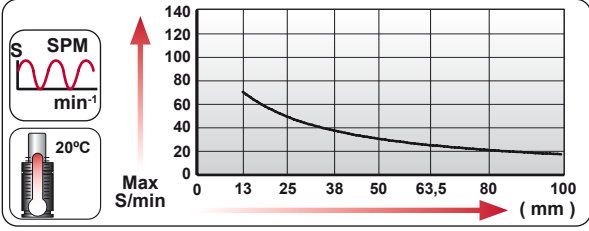

N <sub>2</sub>	Smax < 90%	Vmax 1,6 m/s	bar psi	bar psi	°C °F	°C °F	X
			20 290	150 2175	0 32	80 176	

**E08-038**

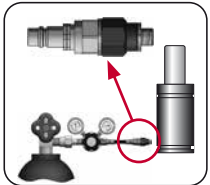
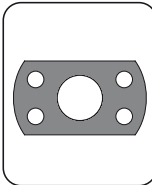
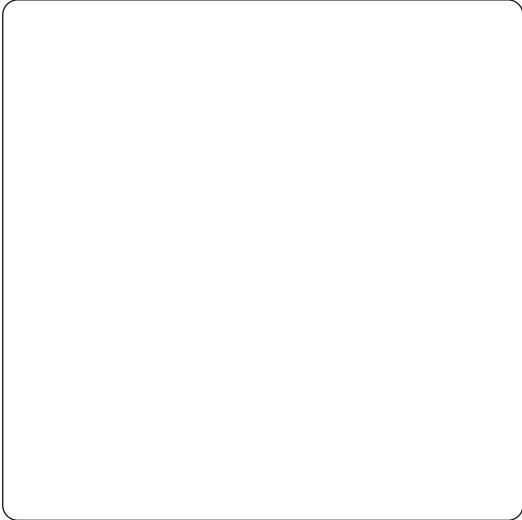
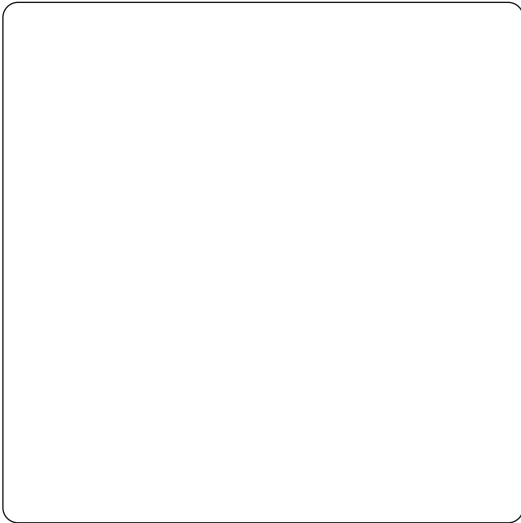
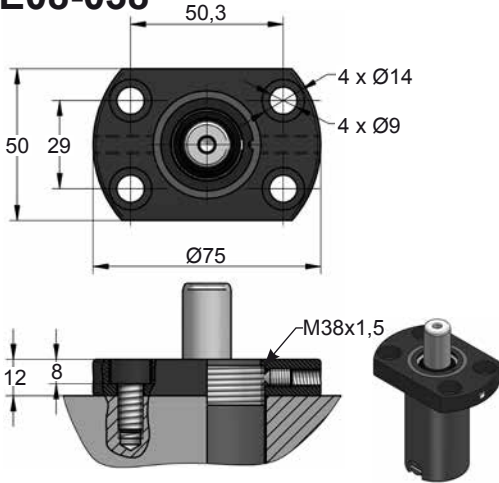

CODE	ASP 300 050	KIT S-XXXXXXX KIT C-XXXXXXX	E08-038	06 CG 2-Q
ENG ORDER	GAS SPRING	REPAIR KIT	FLANGE	CHARGING ADAPTER
DEU BESTELLUNG	GASDRUCKFEDER	ERSATZTEILSATZ	FLANSCHEN	LADEADAPTER
FRA COMMANDE	RESSORT À GAZ	KIT DE RÉPARATION	BRIDE	RACCORD DE CHARGE
ITA ORDINE	CILINDRO AD AZOTO	KIT DI MANUTENZIONE	FLANGE	ADATTATORE DI CARICO
ESP PEDIDO	RESORTE DE GAS	KIT DE REPARACION	BRIDA	ADAPTADOR DE CARGA
POR PEDIDO	CILINDRO DE GAS	KIT DE MANUTENÇÃO	FLANGE	ADAPTADOR DE CARGA