

CK 1500 V2

Low Profile

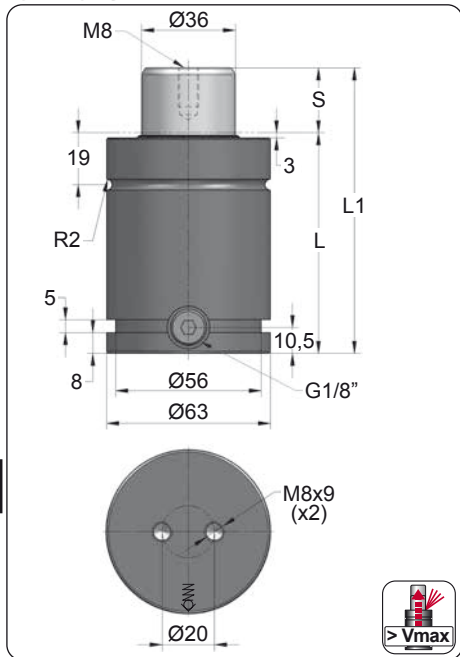



ORDER	S (mm)	L1 ±0,25 (mm)	L (mm)	Kg.
CK 1500 012 V2	12	84	72	1.28
CK 1500 025 V2	25	110	85	1.44
CK 1500 038 V2	38	136	98	1.61
CK 1500 050 V2	50	160	110	1.77
CK 1500 063 V2	63	186	123	1.93
CK 1500 080 V2	80	220	140	2.15
CK 1500 100 V2	100	260	160	2.41

CODE				
	bar	psi	daN	daN
CK 1500 050 V2	150	2175	1530	2605
CK-H 1500 050 V2	0	0	---	---

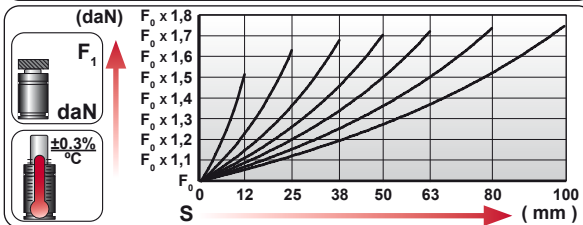
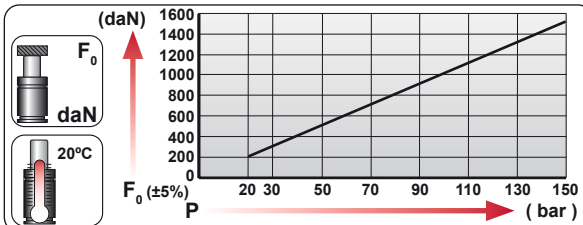

ENG ORDER
 DEU BESTELLUNG
 FRA COMMANDE
 ITA ORDINE
 ESP PEDIDO
 POR PEDIDO

F₀ daN
S mm

CK 1500 50
CK 1500 050 V2

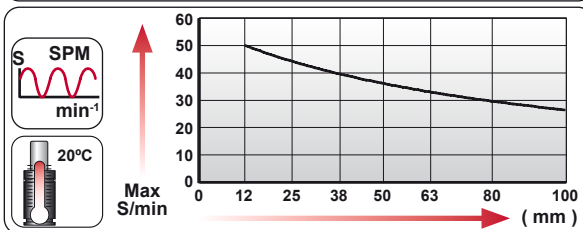

	S_{max} < 90%	V_{max} 1,6 m/s	P_{min} (20°C)	P_{max} (20°C)	T_{min}	T_{max}	
--	---------------------------------	--------------------------------	-------------------------------	-------------------------------	------------------------	------------------------	--

N ₂	S _{max} < 90%	V _{max} 1,6 m/s	bar psi	bar psi	°C °F	°C °F	600 CP-
			20 290	150 2175	0 32	80 176	



CK 1500 V2 MOUNTS

Low Profile

MODEL	X	CW 1500 KZ 1500	X	CT 1500 CK 1500	CM 1500 CD 1500	X	CPH 2800 CP 3000	CS 3000
SERIES	MINI	COMPACT HEIGHT	THREADED	LOW PROFILE	HEAVY DUTY	ISO	HEAVY LOAD	POWER COMPACT STROKE

A14-063

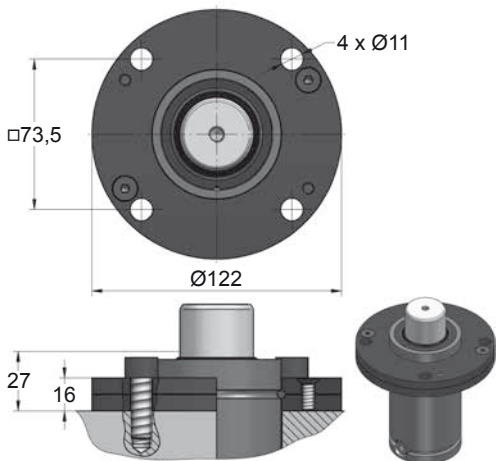

A39-063

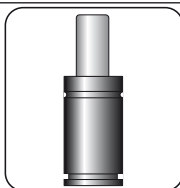
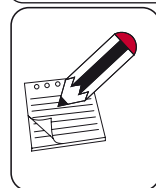
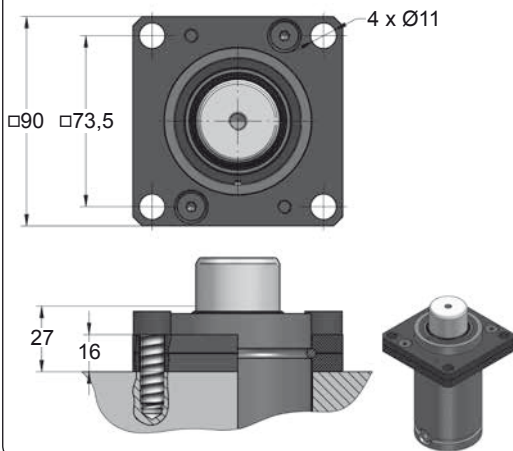

SEAL
KIT S-XXXXXXX

CARTRIDGE
KIT C-XXXXXXX

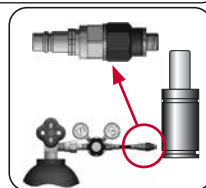
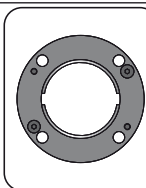

CODE	CK 1500 050 V2	KIT S-XXXXXXX KIT C-XXXXXXX	A14-063	18 CG 1-Q
ENG ORDER	GAS SPRING	REPAIR KIT	FLANGE	CHARGING ADAPTER
DEU BESTELLUNG	GASDRUCKFEDER	ERSATZTEILSATZ	FLANSCHEN	LADEADAPTER
FRA COMMANDE	RESSORT À GAZ	KIT DE RÉPARATION	BRIDE	RACCORD DE CHARGE
ITA ORDINE	CILINDRO AD AZOTO	KIT DI MANUTENZIONE	FLANGE	ADATTATORE DI CARICO
ESP PEDIDO	RESORTE DE GAS	KIT DE REPARACION	BRIDA	ADAPTADOR DE CARGA
POR PEDIDO	CILINDRO DE GÁS	KIT DE MANUTENÇÃO	FLANGE	ADAPTADOR DE CARGA

CK 1500 V2 MOUNTS

Low Profile

AZOL
GAS

A69-063

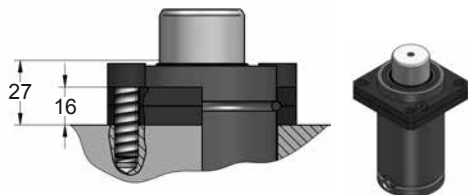
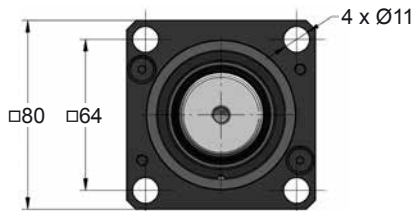

B21-063

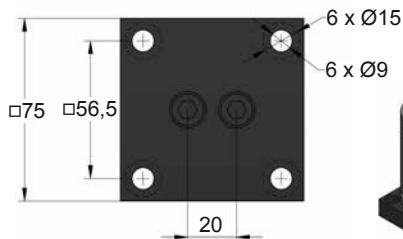
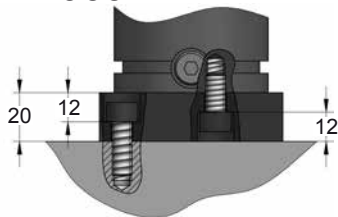

B76-063

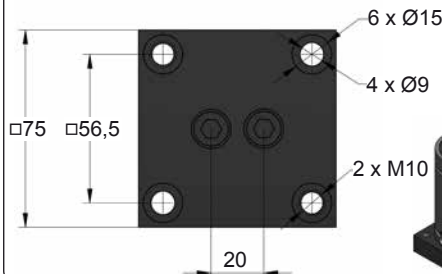
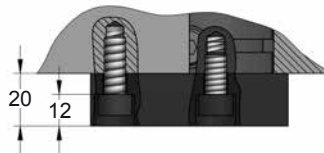

SEAL
KIT S-XXXXXXX



CARTRIDGE
KIT C-XXXXXXX

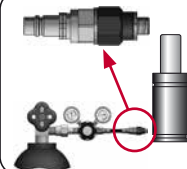
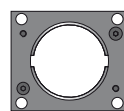

CODE	CK 1500 050 V2	KIT S-XXXXXXX KIT C-XXXXXXX	A69-063	18 CG 1-Q
ENG	ORDER	GAS SPRING	REPAIR KIT	FLANGE
DEU	BESTELLUNG	GASDRUCKFEDER	ERSATZTEILSATZ	FLANSCHEN
FRA	COMMANDE	RESSORT À GAZ	KIT DE RÉPARATION	BRIDE
ITA	ORDINE	CILINDRO AD AZOTO	KIT DI MANUTENZIONE	FLANGE
ESP	PEDIDO	RESORTE DE GAS	KIT DE REPARACION	BRIDA
POR	PEDIDO	CILINDRO DE GÁS	KIT DE MANUTENÇÃO	FLANGE
				CHARGING ADAPTER
				LADEADAPTER
				RACCORD DE CHARGE
				ADATTATORE DI CARICO
				ADAPTADOR DE CARGA
				ADAPTADOR DE CARGA

C05-063

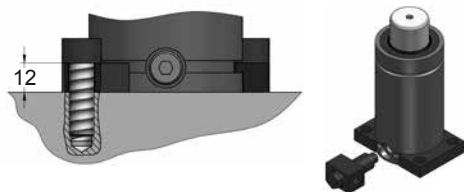
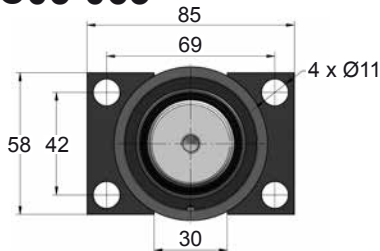

C35-063

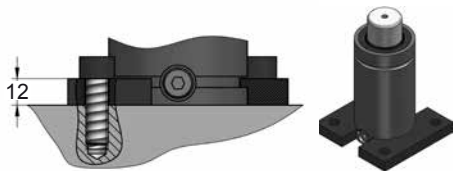
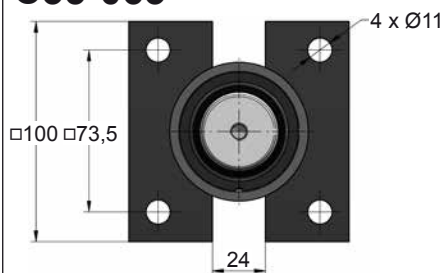

D02-063

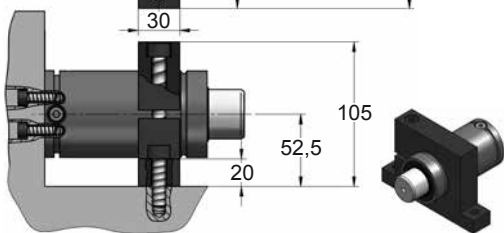
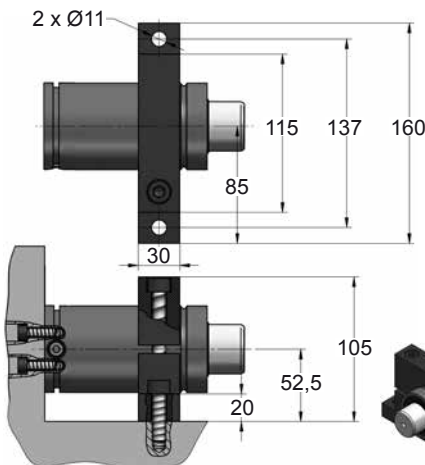

D67-063

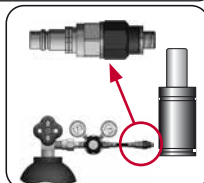
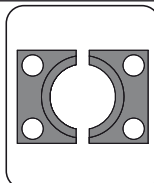
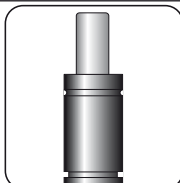
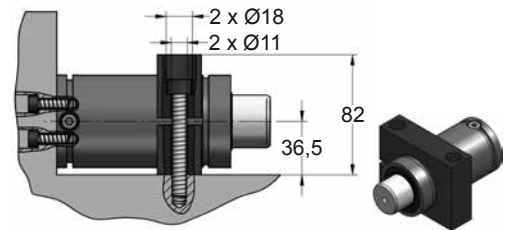
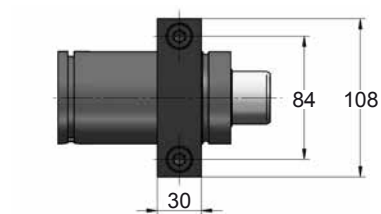

CODE	CK 1500 050 V2	KIT S-XXXXXXX KIT C-XXXXXXX	C05-063	18 CG 1-Q
ENG ORDER	GAS SPRING	REPAIR KIT	FLANGE	CHARGING ADAPTER
DEU BESTELLUNG	GASDRUCKFEDER	ERSATZTEILSATZ	FLANSCHEN	LADEADAPTER
FRA COMMANDE	RESSORT À GAZ	KIT DE RÉPARATION	BRIDE	RACCORD DE CHARGE
ITA ORDINE	CILINDRO AD AZOTO	KIT DI MANUTENZIONE	FLANGE	ADATTATORE DI CARICO
ESP PEDIDO	RESORTE DE GAS	KIT DE REPARACION	BRIDA	ADAPTADOR DE CARGA
POR PEDIDO	CILINDRO DE GÁS	KIT DE MANUTENÇÃO	FLANGE	ADAPTADOR DE CARGA