

AS 300

Threaded

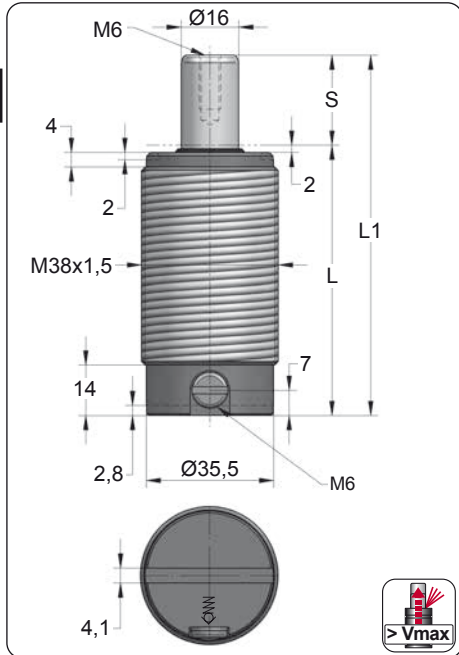



ORDER	S (mm)	L1 ±0,25 (mm)	L (mm)	Kg.
AS 300 012	12.7	75.4	62.7	0.42
AS 300 025	25	100	75	0.48
AS 300 038	38	126	88	0.54
AS 300 050	50	150	100	0.60
AS 300 063	63.5	177	113.5	0.67
AS 300 080	80	210	130	0.75
AS 300 100	100	250	150	0.85
AS 300 125	125	300	175	0.98

CODE				
	bar	psi	daN	daN
AS 300 050	150	2175	300	415
-----	---	---	---	---

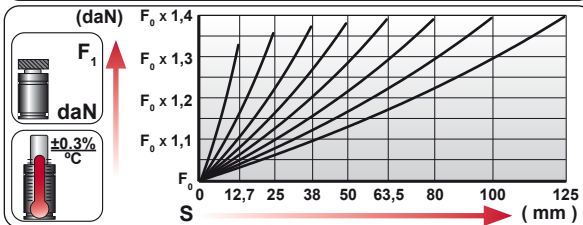
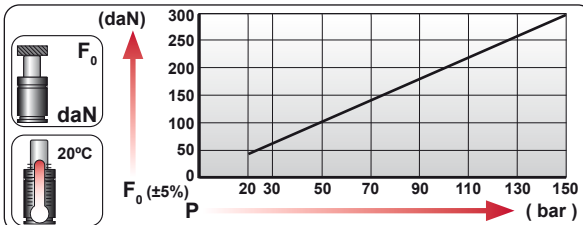

	ENG ORDER DEU BESTELLUNG FRA COMMANDE ITA ORDINE ESP PEDIDO POR PEDIDO		
		daN	mm
		AS 300	50
		AS 300 050	

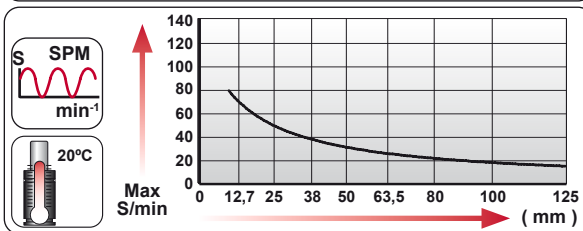

N ₂	S _{max} < 90%	V _{max} 1,6 m/s	P _{min} (20°C)	P _{max} (20°C)	T _{min}	T _{max}	

N ₂	S _{max} < 90%	V _{max} 1,6 m/s	bar psi	bar psi	°C °F	°C °F	°C °F	
			20 290	150 2175	0 32	80 176		



AS 300 MOUNTS

Threaded

E23-038

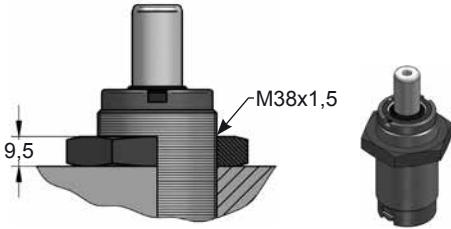
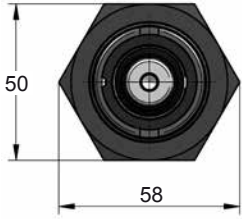

E58-038

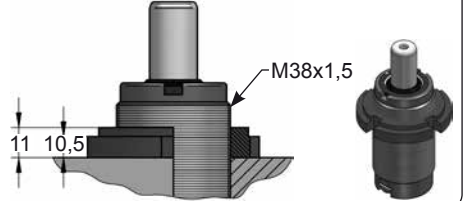
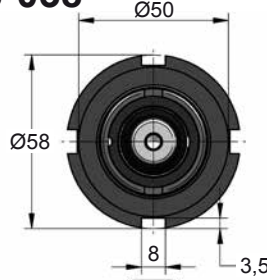

E68-038

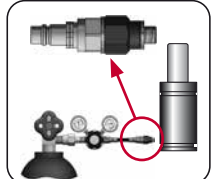
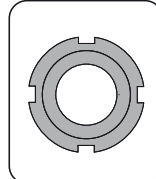
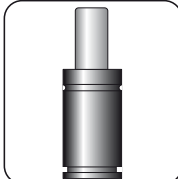
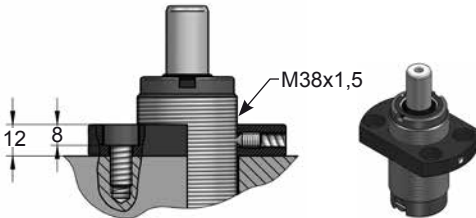
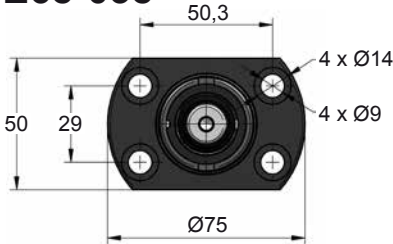

CODE	AS 300 050	KIT S-XXXXXXX KIT C-XXXXXXX	E58-038	06 CG 2-Q
ENG ORDER	GAS SPRING	REPAIR KIT	FLANGE	CHARGING ADAPTER
DEU BESTELLUNG	GASDRUCKFEDER	ERSATZTEILSATZ	FLANSCHEN	LADEADAPTER
FRA COMMANDE	RESSORT À GAZ	KIT DE RÉPARATION	BRIDE	RACCORD DE CHARGE
ITA ORDINE	CILINDRO AD AZOTO	KIT DI MANUTENZIONE	FLANGE	ADATTATORE DI CARICO
ESP PEDIDO	RESORTE DE GAS	KIT DE REPARACION	BRIDA	ADAPTADOR DE CARGA
POR PEDIDO	CILINDRO DE GAS	KIT DE MANUTENÇÃO	FLANGE	ADAPTADOR DE CARGA