

CW 350 V1

Compact Height

BMW B2 4005	FORD W-DX35-6204	
MB B8 3180 220 000 004	GM 90.25.08	
VW 39D 997		

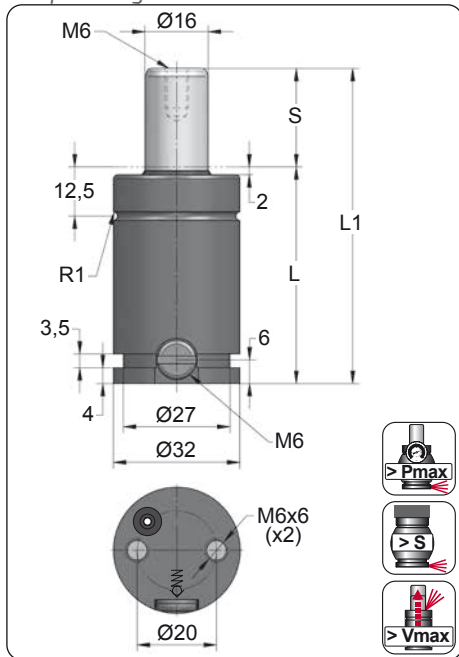

ORDER	S (mm)	L1 ±0.25 (mm)	L (mm)	Kg.
CW 350 010 V1	10	50	40	0.18
CW 350 013 V1	13	56	43	0.19
CW 350 016 V1	16	62	46	0.20
CW 350 019 V1	19	68	49	0.21
CW 350 025 V1	25	80	55	0.23
CW 350 032 V1	32	94	62	0.25
CW 350 038 V1	38	106	68	0.28
CW 350 050 V1	50	130	80	0.32
CW 350 063 V1	63	156	93	0.36
CW 350 075 V1	75	180	105	0.40
CW 350 080 V1	80	190	110	0.42
CW 350 100 V1	100	230	130	0.49
CW 350 125 V1	125	280	155	0.57



CODE				
	bar	psi	daN	daN
CW 350 050 V1	180	2610	360	550
CW-H 350 050 V1	0	0	---	---

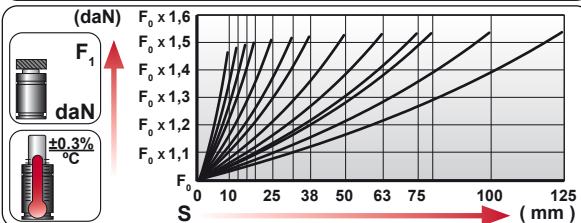
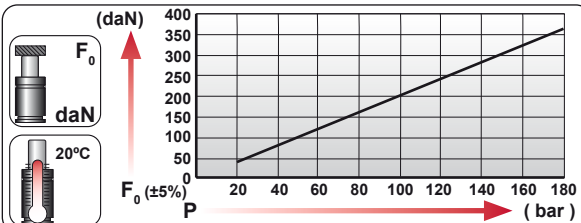

EQUIPPED WITH VDI - SAFETY

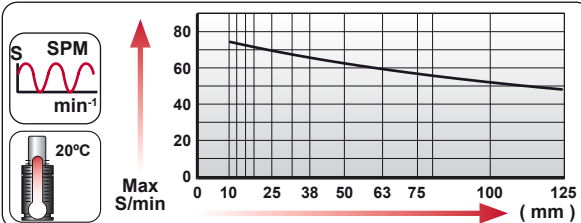

ENG	ORDER
DEU	BESTELLUNG
FRA	COMMANDE
ITA	ORDINE
ESP	PEDIDO
POR	PEDIDO

CW 350 050 V1 **350** **50**

N ₂	S _{max} < 90%	V _{max} 1,6 m/s	P _{min} (20°C)	P _{max} (20°C)	T _{min}	T _{max}	600 CP-

bar	psi	bar	psi	°C	°F	°C	°F
20	290	180	2610	0	32	80	176

A14-032

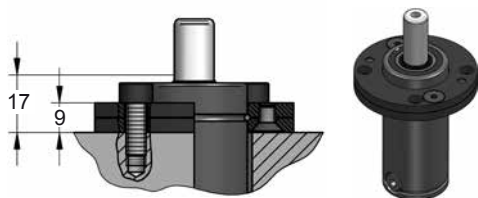
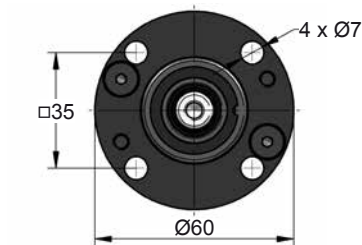

A34-032

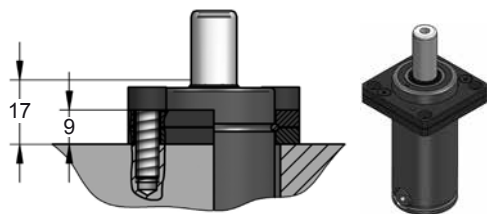
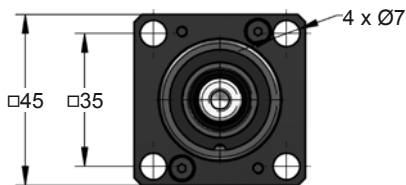

C20-032

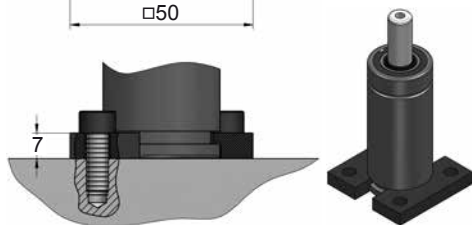
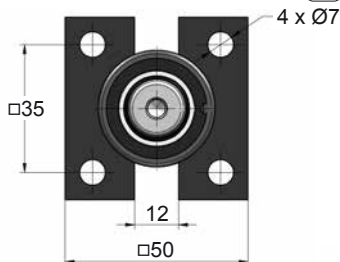

D02-032

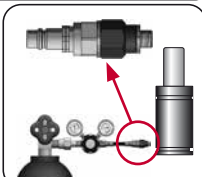
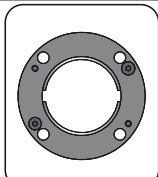
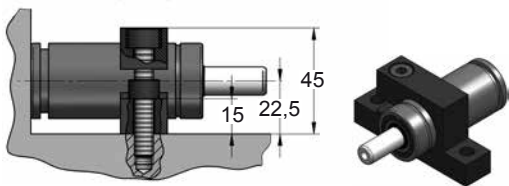
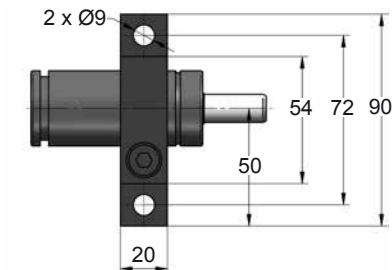

CODE	CW 350 050 V1	KIT S-XXXXXXX KIT C-XXXXXXX	A14-032	06 CG 2-Q
ENG ORDER	GAS SPRING	REPAIR KIT	FLANGE	CHARGING ADAPTER
DEU BESTELLUNG	GASDRUCKFEDER	ERSATZTEILSATZ	FLANSCH	LADEADAPTER
FRA COMMANDE	RESSORT À GAZ	KIT DE RÉPARATION	BRIDE	RACCORD DE CHARGE
ITA ORDINE	CILINDRO AD AZOTO	KIT DI MANUTENZIONE	FLANGE	ADATTATORE DI CARICO
ESP PEDIDO	RESORTE DE GAS	KIT DE REPARACION	BRIDA	ADAPTADOR DE CARGA
POR PEDIDO	CILINDRO DE GAS	KIT DE MANUTENÇÃO	FLANGE	ADAPTADOR DE CARGA