

CM 200

Heavy Duty

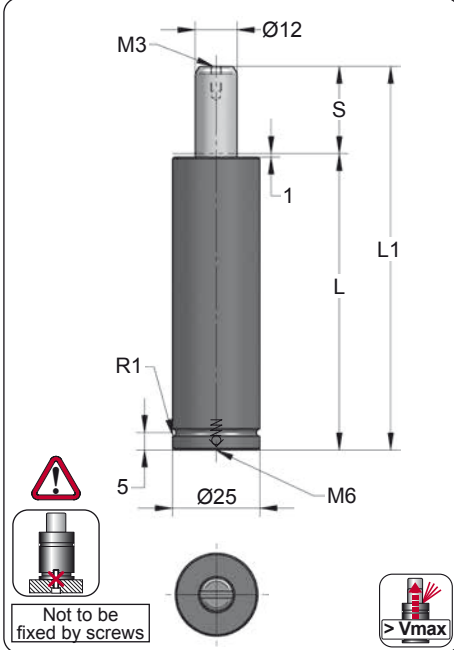



ORDER	S (mm)	L1 ±0,25 (mm)	L (mm)	Kg.
CM 200 010	10	80	70	0.22
CM 200 015	15	90	75	0.23
CM 200 025	25	110	85	0.25
CM 200 038	38	136	98	0.28
CM 200 050	50	160	110	0.30
CM 200 063	63.5	186.5	123	0.33
CM 200 080	80	220	140	0.36

CODE				
		bar psi	daN	daN
CM 200 050		180 2610	205	290
-----		-----	-----	-----

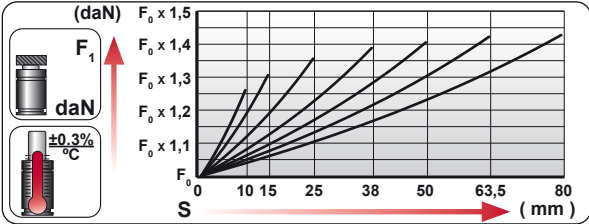
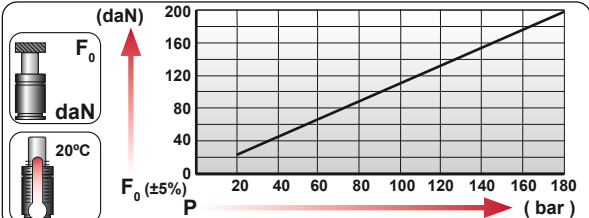

ENG	ORDER		
DEU	BESTELLUNG	daN	mm
FRA	COMMANDE		
ITA	ORDINE		
ESP	PEDIDO		
POR	PEDIDO		
	CM 200 50		
	CM 200 050		

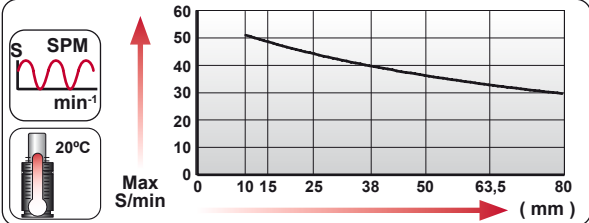

N ₂	S _{max} < 90%	V _{max} 1,6 m/s	P _{min} (20°C)	P _{max} (20°C)	T _{min}	T _{max}	

bar	psi	bar	psi	°C	°F	°C	°F	
20	290	180	2610	0	32	80	176	

A14-025

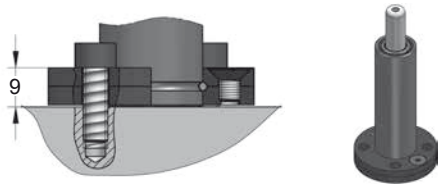
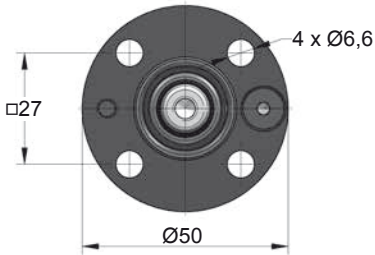

A44-025

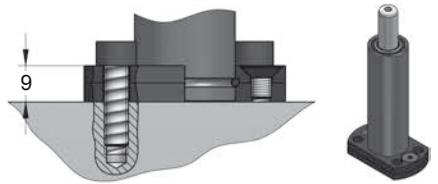
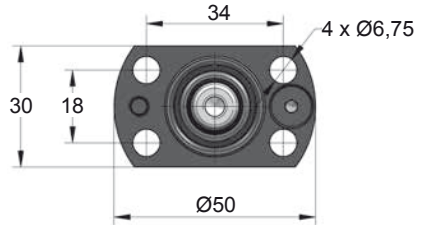

A49-025

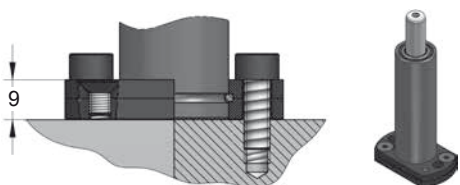
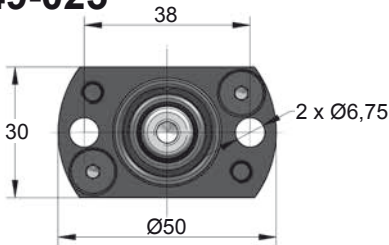

Single base thread

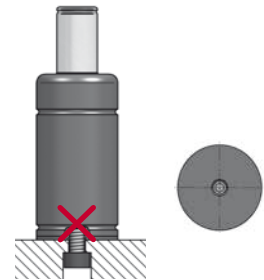

Gas springs with only a single base thread should not be mounted by screws.

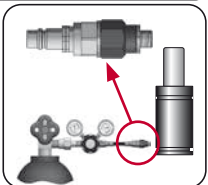
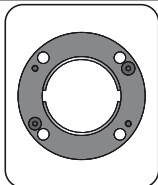
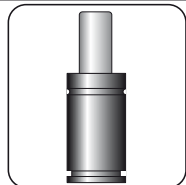
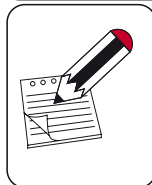

CODE	CM 200 050	KIT S-XXXXXXX KIT C-XXXXXXX	A14-025	06 CG 2-Q	
ENG	ORDER	GAS SPRING	REPAIR KIT	FLANGE	CHARGING ADAPTER
DEU	BESTELLUNG	GASDRUCKFEDER	ERSATZTEILSATZ	FLANSCHEN	LADEADAPTER
FRA	COMMANDE	RESSORT À GAZ	KIT DE RÉPARATION	BRIDE	RACCORD DE CHARGE
ITA	ORDINE	CILINDRO AD AZOTO	KIT DI MANUTENZIONE	FLANGE	ADATTATORE DI CARICO
ESP	PEDIDO	RESORTE DE GAS	KIT DE REPARACION	BRIDA	ADAPTADOR DE CARGA
POR	PEDIDO	CILINDRO DE GÁS	KIT DE MANUTENÇÃO	FLANGE	ADAPTADOR DE CARGA