

CP 2000 V2

Heavy Load

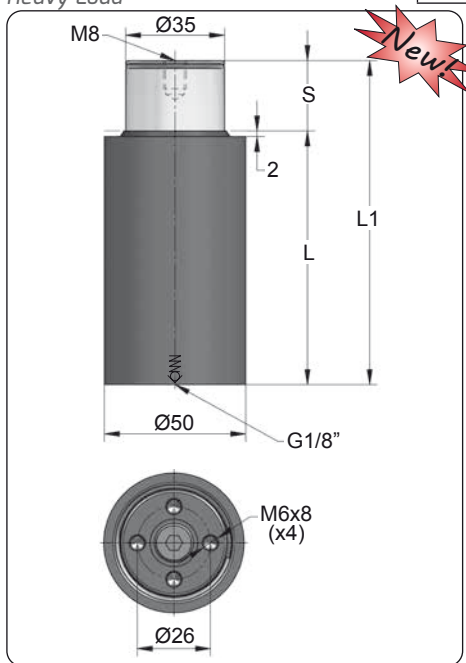



ORDER	S (mm)	L1 ±0,25 (mm)	L (mm)	Kg.
CP 2000 010 V2	10	80	70	0.87
CP 2000 015 V2	15	95	80	0.95
CP 2000 025 V2	25	115	90	1.05
CP 2000 038 V2	38	150	112	1.23
CP 2000 050 V2	50	175	125	1.35
CP 2000 063 V2	63	205	142	1.50
CP 2000 080 V2	80	245	165	1.71



CODE				
	bar	psi	daN	daN
CP 2000 050 V2	200	2900	1925	3500
-----	---	---	---	---

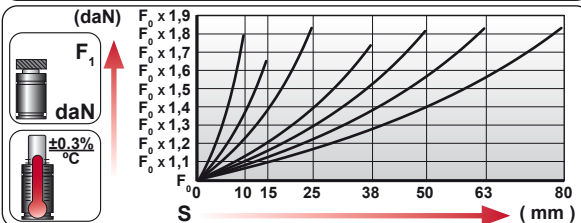
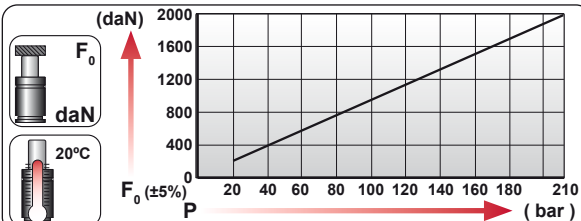

	ENG ORDER DEU BESTELLUNG FRA COMMANDE ITA ORDINE ESP PEDIDO POR PEDIDO		
		daN	mm
	CP 2000 50		
	CP 2000 050 V2		

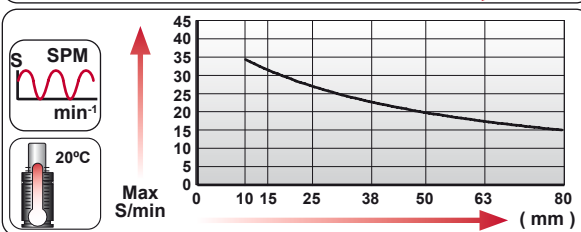











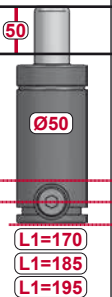
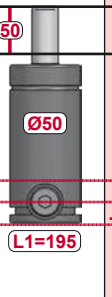
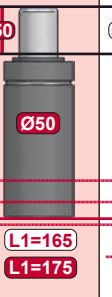

N ₂	S _{max} < 90%	V _{max} 0,5 m/s	P _{min} (20°C)	P _{max} (20°C)	T _{min}	T _{max}	

N ₂	S _{max} < 90%	V _{max} 0,5 m/s	bar psi	bar psi	°C °F	°C °F	°C °F	
			20 290	210 3045	0 32	80 176		

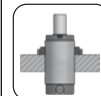
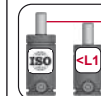
CP 2000 V2 MOUNTS

Heavy Load

								
			Ø50 L1=138 L1=152	Ø50 L1=138 L1=150 L1=150	Ø50 L1=170 L1=185 L1=195	Ø50 L1=195	Ø50 L1=165 L1=175	Ø50 L1=220
MODEL	X CW 1000 KZ 1000	X	CT 1000 CK 1000 FD 750	GN 750 CM 1000 CD 1000	AG 750	CPH 1700 CP 2000	CS 1800	
SERIES	MINI 	COMPACT HEIGHT 	THREADED 	LOW PROFILE 	HEAVY DUTY 	ISO 	HEAVY LOAD 	POWER COMPACT STROKE 

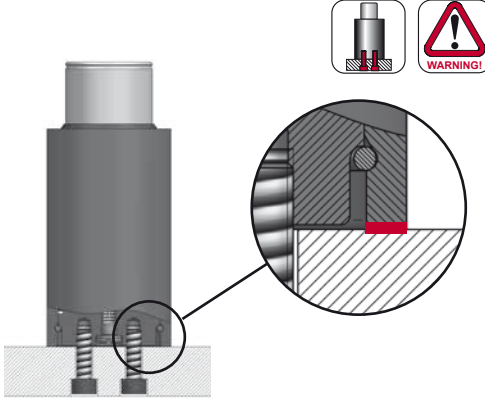

When using CP series mounted by screws the gas spring must be supported at all the times.
A flat support surface in contact with the whole surface of the gas spring body is always required.

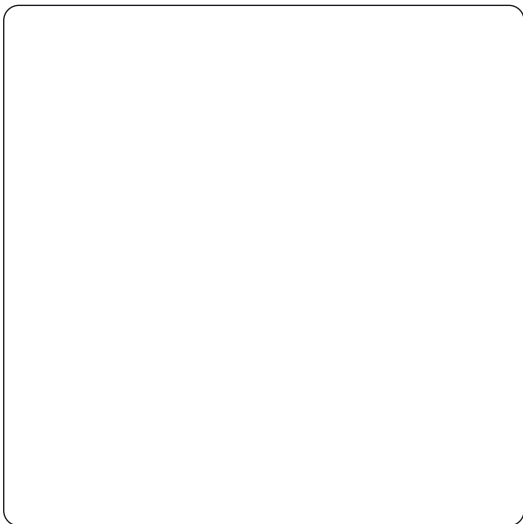

				
--	---	---	---	--

CODE	CP 2000 050 V2	KIT S-XXXXXXX	X	18 CG 1-Q
ENG ORDER	GAS SPRING	REPAIR KIT	FLANGE	CHARGING ADAPTER
DEU BESTELLUNG	GASDRUCKFEDER	ERSATZTEILSATZ	FLANSCHEN	LADEADAPTER
FRA COMMANDE	RESSORT À GAZ	KIT DE RÉPARATION	BRIDE	RACCORD DE CHARGE
ITA ORDINE	CILINDRO AD AZOTO	KIT DI MANUTENZIONE	FLANGE	ADATTATORE DI CARICO
ESP PEDIDO	RESORTE DE GAS	KIT DE REPARACION	BRIDA	ADAPTADOR DE CARGA
POR PEDIDO	CILINDRO DE GÁS	KIT DE MANUTENÇÃO	FLANGE	ADAPTADOR DE CARGA