

AS 200

Threaded

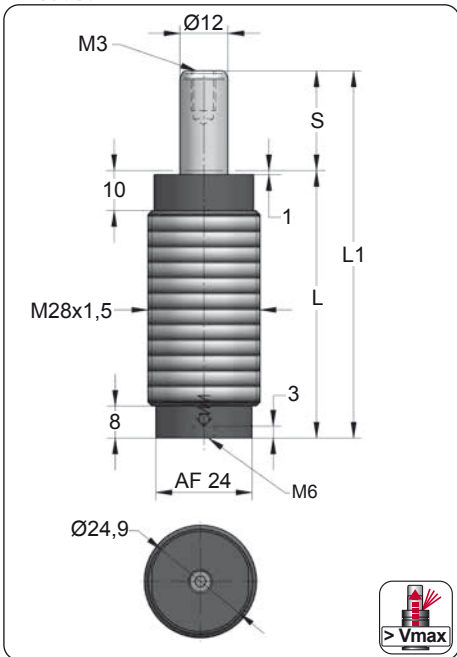

CODE	S (mm)	L1 ±0,25 (mm)	L (mm)	Kg.
AS ... 010	10	62	52	0.19
AS ... 012	12.7	67.4	54.7	0.20
AS ... 016	16	74	58	0.21
AS ... 025	25	92	67	0.24
AS ... 038	38	118	80	0.27
AS ... 050	50	142	92	0.31
AS ... 063	63.5	169	105.5	0.35
AS ... 080	80	202	122	0.39
AS ... 100	100	242	142	0.45
AS ... 125	125	292	167	0.52



CODE	COLOR	Pressure		Force	
		bar	psi	daN	daN
AS 50 050	Green	45	650	50	70
AS 100 050	Blue	90	1305	100	145
AS 150 050	Red	135	1960	150	215
AS 200 050	Yellow	180	2610	200	285

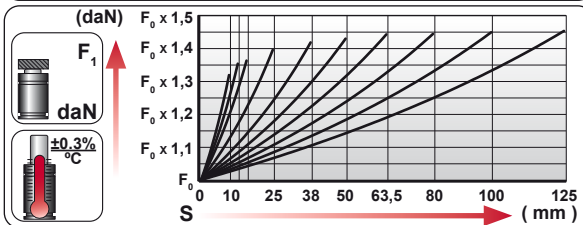
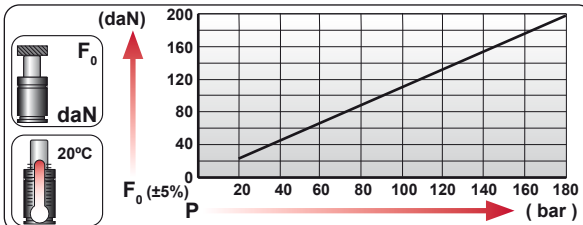

	ENG ORDER		daN	mm
	DEU BESTELLUNG			
	FRA COMMANDE			
	ITA ORDINE			
	ESP PEDIDO			
POR PEDIDO				

AS 200 50

AS 200 050

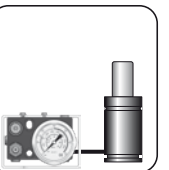
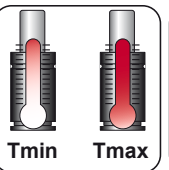
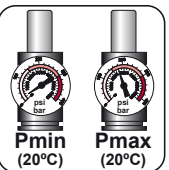
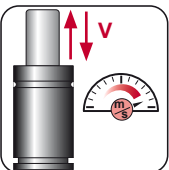
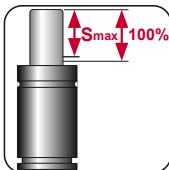
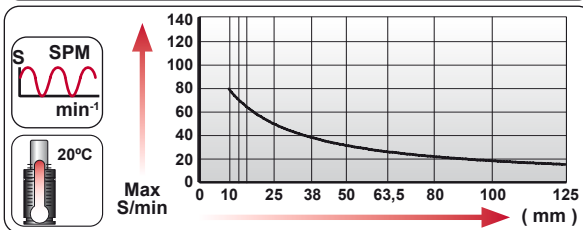

N ₂	Smax < 90%	Vmax 1,6 m/s	bar psi	bar psi	°C °F	°C °F	°C °F	°C °F	X
			20 290	180 2610	0 32	80 176			

E58-028

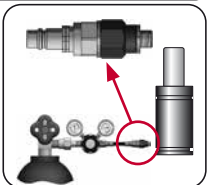
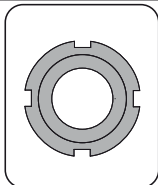
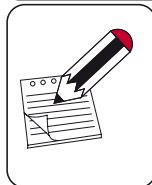
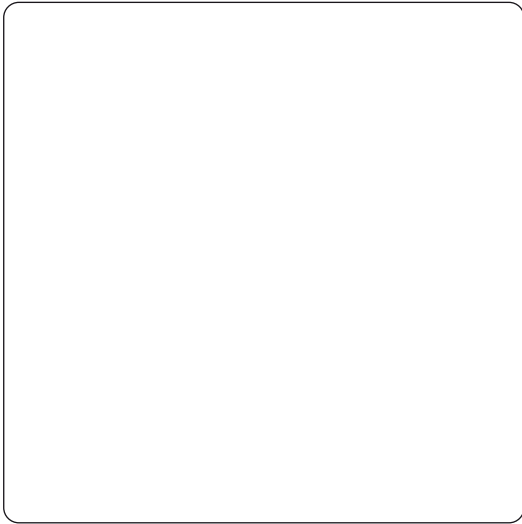
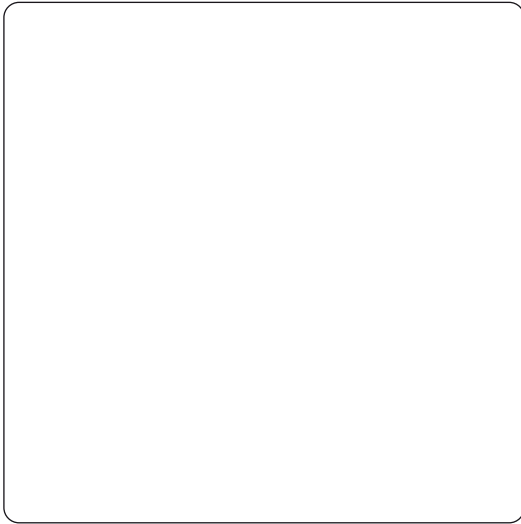
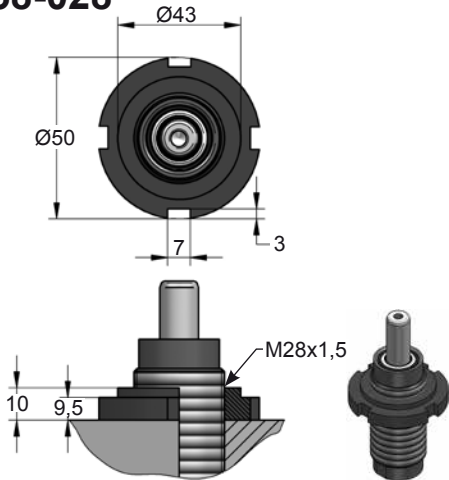

CODE	AS 200 050	KIT S-XXXXXXX KIT C-XXXXXXX	E58-028	06 CG 2-Q
ENG ORDER	GAS SPRING	REPAIR KIT	FLANGE	CHARGING ADAPTER
DEU BESTELLUNG	GASDRUCKFEDER	ERSATZTEILSATZ	FLANSCHEN	LADEADAPTER
FRA COMMANDE	RESSORT À GAZ	KIT DE RÉPARATION	BRIDE	RACCORD DE CHARGE
ITA ORDINE	CILINDRO AD AZOTO	KIT DI MANUTENZIONE	FLANGE	ADATTATORE DI CARICO
ESP PEDIDO	RESORTE DE GAS	KIT DE REPARACION	BRIDA	ADAPTADOR DE CARGA
POR PEDIDO	CILINDRO DE GÁS	KIT DE MANUTENÇÃO	FLANGE	ADAPTADOR DE CARGA